

AUS

**KNIGHTWOOD LED ELECTRIC FIRE
INSTALLATION & USER INSTRUCTIONS**

**BRITISH
FIRES**



TABLE OF CONTENTS

SECTION	CONTENTS	PAGE
1.0	Important Notes	02
2.0	Installation Requirements	03
3.0	Appliance Data	04
4.0	Component Checklist	05
5.0	Site Requirements	05
6.0	Clearances To Combustibles	06
7.0	Unpacking The Appliance	06
8.0	Preparing the Appliance	07
8.1	Removing the Front Glass	07-08
9.0	Installation Overview	09
9.1	Installation - Existing Opening	09-10
9.2	Installation - Stud Wall	11-12
10.0	Installing the Deluxe Real Logs	13
11.0	Pairing the Remote Control	15
12.0	Operating the Knightwood	16-19
13.0	Safety Cut-Out System	20
14.0	Cleaning and Maintenance	20
15.0	Troubleshooting Guide	21
16.0	Servicing	22
17.0	Spare Parts	23
18.0	Dimensions	24
19.0	Guarantee, Terms & Conditions	25

1.0 IMPORTANT NOTES

IMPORTANT – THESE INSTRUCTIONS SHOULD BE READ CAREFULLY AND RETAINED FOR FUTURE REFERENCE.

When using this electrical appliance, basic precautions should be followed to reduce the risk of fire, electric shock and injury to person, including the following:

This heater must be used on an AC supply only and the voltage marked on the heater's rating label must correspond to the supply voltage.

DO NOT switch the appliance on until it is properly installed as described in this manual.

This appliance can be used by children aged from 8 years and above and persons with reduced physical, sensory or mental capabilities or lack of experience and knowledge if they have been given supervision or instruction concerning use of the appliance in a safe way and understand the hazards involved. Children shall not play with the appliance. Cleaning and user maintenance shall not be made by children without supervision.

Children of less than 3 years should be kept away unless continuously supervised. Children aged from 3 years and less than 8 years shall only switch on/off the appliance provided that it has been placed or installed in its intended normal operating position and they have been given supervision or instruction concerning use of the appliance in a safe way and understand the hazards involved.

Children aged from 3 years and less than 8 years shall not plug in, regulate and clean the appliance or perform user maintenance.

CAUTION: Some parts of this appliance can become very hot and cause burns. Particular attention has to be given where children and vulnerable people are present. Check that all parts included are intact and not damaged. If the supply cord is damaged, it must be replaced by the manufacturer, its service agent or similarly qualified persons in order to avoid a hazard. Never use the appliance if the cord or any part of the appliance shows signs of damage. The heater must not be located immediately below a socket-outlet.

DO NOT use this heater in the immediate surroundings of a bath, a shower or a swimming pool.

WARNING: In order to avoid overheating,  DO NOT cover the fan of the heater.

DO NOT use this heater with a programmer, timer, separate remote-control system or any other device that switches the heater on automatically, since a fire risk exists if the heater is covered or positioned incorrectly.

CAUTION: In order to avoid a hazard due to inadvertent resetting of the thermal cut-out, this appliance must not be supplied through an external switching device, such as a timer, or connected to a circuit that is regularly switched on and off by the utility.

WARNING: This heater is not equipped with a device to control the room temperature. Do not use this heater in small rooms when they are occupied by persons not capable of leaving the room on their own, unless

constant supervision is provided.

Keep furniture, curtains and other fabric material away from appliance.

DO NOT leave the appliance unattended during use.

DO NOT run the mains cable under carpets, rugs etc.

 DO NOT cover or obstruct the heater in any way. Overheating will result if it is accidentally covered.

Never immerse the appliance in water or any other liquids.

DO NOT use the appliance outdoors.

Before cleaning the appliance, ensure it is unplugged from the power and that it is completely cool.

DO NOT clean the appliance with abrasive chemicals.

Never use accessories that are not recommended or supplied by the manufacturer. It could cause danger to the user or damage to the appliance.

DO NOT insert or allow foreign objects to enter the inlet or outlet vents as this may result in electric shock, fire or damage to the appliance.

DO NOT install the fire using an extension cord.

Unplug from the mains supply if the appliance is not to be used for long periods. This appliance is only suitable for well-insulated spaces or occasional use.

DO NOT use this appliance in an open flue.

2.0 INSTALLATION REQUIREMENTS

These appliances are supplied with a pre-wired three pin plug and 1.8 metres of electrical cable. It is therefore necessary for a suitable electrical socket to be located within this distance and be easily accessible. The appliances are suitable for installation in static holiday/park homes. The appliances may be hard wired into a fuse spur, providing that the fuse spur is external to the installation and easily accessible, this must be carried out by a service agent or competent person, such as a qualified electrician. This heater is for use on 220–240 volts. The cord is a 3-pin plug as shown below and is 1.8m.

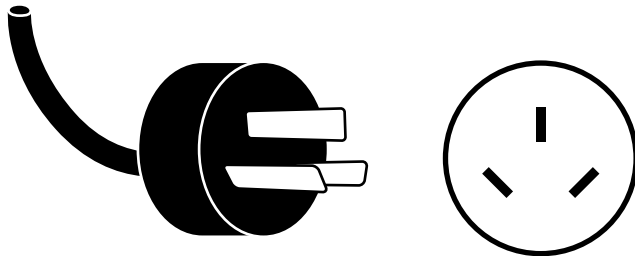

KNIGHTWOOD LED ELECTRIC FIRE

Weight	70 kg
Dimensions	1525 x 802 x 392.5 mm
Supply Voltage & Rating Power	220–240V AC, 50Hz
Fuse Rating	13 Amp
Heating Elements	1260 - 1500W
Lighting	LED

WARNING:

Before enclosing the appliance, test the power in situation in order to ensure the power to the appliance working properly.

3.0 APPLIANCE DATA

Item	Symbol	Value	Unit
HEAT OUTPUT			
Nominal heat output	Pnom	1.5	KW
Minimum heat output (indicative)	Pmin	0.75	KW
Maximum continuous heat output	Pmax, c	1.5	KW

AUXILIARY ELECTRICITY CONSUMPTION			
At nominal heat output	elmax	0.0	KW
At minimum heat output	elmin	0.0	KW
In standby mode	eISB	0.0	KW

This fire is fitted with Light Emitting Diode's (LEDs) in place of conventional bulbs. LEDs generate the same light levels as conventional bulbs, but use a fraction of the energy consumed.

Item	Unit
TYPES OF HEAT INPUT, FOR ELECTRIC STORAGE LOCAL SPACE HEATERS ONLY	
Manual heat charge control with integrated thermostat	N/A
Manual heat charge control with room and/or outdoor temperature feedback	N/A
Electronic heat charge control with room and/or outdoor temperature feedback	N/A
Fan assisted heat output	N/A

TYPE OF HEAT OUTPUT/ROOM TEMPERATURE CONTROL	
Single stage heat output and no room temperature control	No
Two or more manual stages no temperature control	No
With mechanical thermostat room temperature control	Yes
With electronic room temperature control	No
Electronic room temperature control plus day timer	Yes
Electronic room temperature control plus week timer	Yes

Item	Unit
OTHER CONTROL OPTIONS	
Room temperature control with presence detection	No
Room temperature control with open window detection	Yes
With distance control option	No
With adaptive start control	No
With working time limitation	No
With black bulb sensor	No

The data label, including the model and serial number, can be found inside the fire underneath the heat assembly housing.

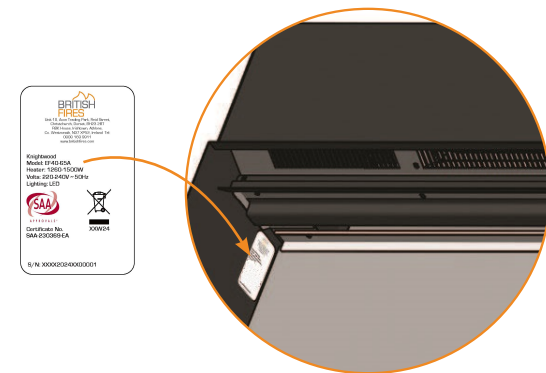

**BRITISH
FIRE**
100, The Boulevard, Borehamwood, Herts, SG9 6ND, UK
 Tel: 01438 750000
 Fax: 01438 750001
 Email: sales@britishfire.co.uk
 www.britishfire.co.uk

Kristofrost
 Model FT40 LED
 Heater 1500W/1500W
 Made 2015/1600 - 0316
 Lighting LED

SAA   

CE Certificate No.
 SAA 0000016

S/N XXXX034000001

4.0 COMPONENT CHECKLIST

QUANTITY	DESCRIPTION
1	Heater unit
1	Remote control handset
2	AAA batteries
16	Wall plugs
16	Wall screws
2	Glass suction cups
1	Deluxe Real Logs

IMPORTANT

WHEN UNPACKING THE PRODUCT PLEASE
NOTE THE LOOSE COMPONENTS ARE IN THE
TOP POLYSTYRENE COMPARTMENTS

5.0 SITE REQUIREMENTS

It should be noted that the appliance creates warm convected air currents. These currents move heat from the room surroundings to, and up the wall surfaces adjacent to the heater.

If the appliance is to be secure on a dry wall or a timber framed construction then the integrity and ability of the wall to secure the appliance must be confirmed. It is important in these circumstances that any vapour barrier and/or structural members of the house frame are not damaged.

If you are unsure of the ability of the wall to secure the appliance and/or which type of wall fixing to use, you should take professional advice and obtain the correct fixings. Alternatively, find a more suitable wall location.

- **DO NOT** run the supply cable under carpets.
- **DO NOT** site in a position where curtains or drapes could cover the appliance, or other soft materials could cover e.g. below a coat rack.
- **DO NOT** site behind an opening door where mechanical impact/damage could occur.
- **DO NOT** site where the supply cable would become a trip hazard.
- **DO NOT** sit, stand or forcefully pull on the appliance.
- **DO NOT** obstruct, cover or force items into the openings.
- **DO NOT** use the heater to dry clothes.
- **DO NOT** site/use in an outdoor location(s).

It is important that the following clearances are maintained from the appliance to combustible materials. These clearances are dependent on the securing location as defined on the following pages.

IMPORTANT

Please read completely through the instructions and verify that all listed parts are present before assembly.

6.0 CLEARANCES TO COMBUSTIBLES

The minimum distance to the front of the appliance is 900mm.

There are no clearances for above or to the side of the appliance, apart from being clear of curtains and drapes for a flush wall installation.

If the stud wall immediately above the heater of the appliance protrudes in front of the appliance rather than finishing flush the over hanging section of the installation must be made from a non-combustible material, such as calcium silicate.

7.0 UNPACKING THE APPLIANCE

Before starting the installation of this fireplace, please read the following:

- 1) The installation should be carried out by two adults to avoid injury or damage. If for any reason it is considered too heavy, please obtain assistance.
- 2) Two or more people may be required to lift the appliance from the pallet. Use gloves to provide additional grip.
- 3) When lifting the electric appliance, always keep your back straight. Bend your legs and not your back. Avoid twisting at the waist. It is better to reposition your feet.
- 4) Avoid upper body and top heavy bending. Always bend from the knees rather than the waist. Do not lean forward or sideways while handling the appliance.
- 5) Use the handles on the sides of the appliance when lifting and moving.
- 6) Always keep the appliance as close to the body as possible. This will minimize the cantilever action.
- 7) Extra safety precautions are required when handling the glass see pages 7-8.
- 8) Remove the front glass from the appliance before removing the tape from either side of the firebox. See section 8.1 on how to remove the front glass.

CAUTION

This appliance is heavy. Always seek assistance whilst unpacking and/or during installation. Please read all the instructions before continuing to unpack or install the appliance.

8.0 PREPARING THE APPLIANCE

Place the appliance in its final installation position. Once in position place a level on top of the appliance to ensure it is level. If it is not level there are adjustable feet at the bottom of the appliance to alter the height. Screw / unscrew the adjustment feet by hand to the desired height.

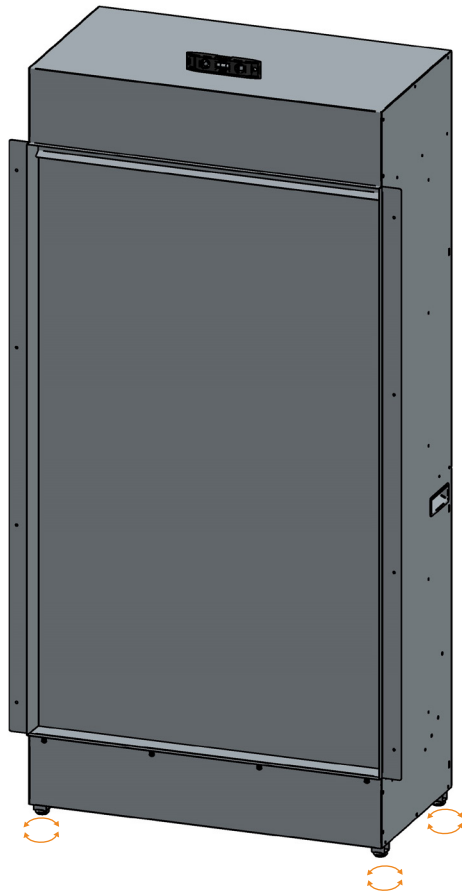

8.1 REMOVING THE FRONT GLASS

We strongly recommend that two people are used to remove the glass, both using protective gloves.

1) To remove the front glass from the appliance, use a cross headed screw driver to remove the four (4x) screws from the glass retaining bracket.

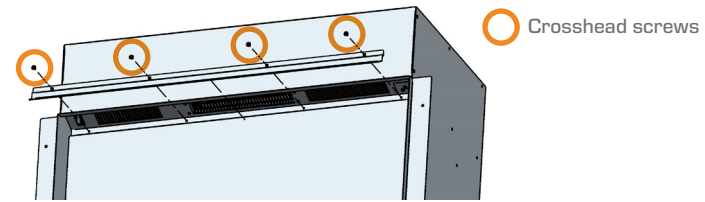

2) Use the suction cups provided to remove the front glass, ensure that the inside of the suction cups and the targeted surface on the glass is wiped clean with a clean lint-free cloth.

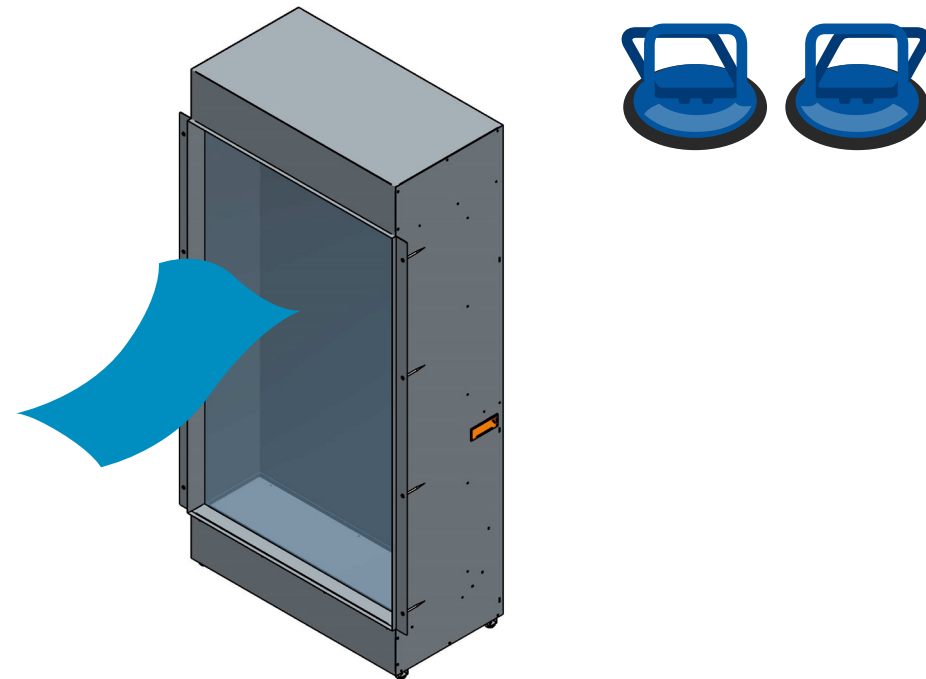

8.1 REMOVING THE FRONT GLASS

Open the handles of the suction cups and press them firmly onto the glass, ensure there are no air bubbles, then place the handles together on each suction cup. Ensure the cups are secure in position on the glass and lift.

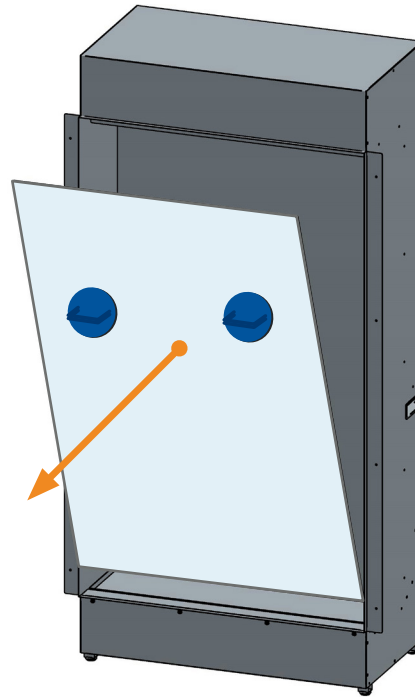
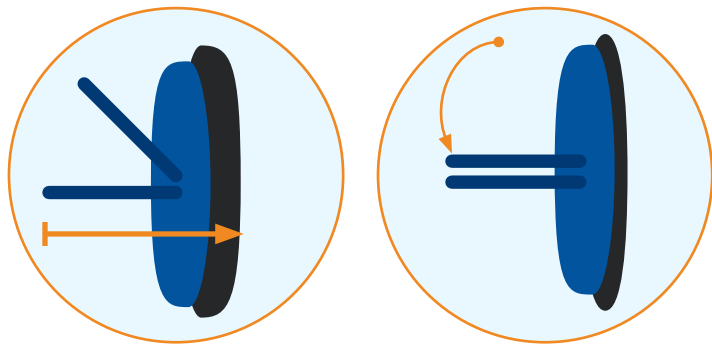

Ensure the glass is supported at all times.

Next, gently lever the top of the glass towards you, ensuring you have full support of the glass.

Lift the glass up and out from the appliance and place the glass on a soft, flat surface on the floor.

Insert the Deluxe Real Log fuel bed as shown in the following pages in section 10.0, page 13.

To re-install the glass, see the instructions in reverse order.

IMPORTANT

Once the front glass has been removed from the appliance, carefully remove the tape from either side of the firebox.

9.0 INSTALLATION OVERVIEW

British Fires assumes absolutely no responsibility for injuries and damages that may occur due to improper installation or handling.

Remove any protective film coatings from the finished/decorative surfaces of the appliance, if any. After having selected the final position of the appliance taking into account the integrity of the wall the electric appliance may be secured to the wall.

To ensure customer safety, be sure to design the installation so that the strength of both the wall and any wall fixings used are sufficient. Do not block the ventilation holes of the appliance. The wall onto which the appliance/stud wall is installed must be flat. Install only on a vertical surface. Avoid sloped surfaces. Installation onto anything other than a vertical wall may result in fire, damage or injury.

If the appliance/stud wall is to be mounted on a dry wall or a timber framed construction wall then efforts should be made to fix into two or more wooden studs, or supporting wooden members of the wall using the fixing screws provided. If this is not achievable then the wall should be strengthened using appropriate building materials.

Ensure that the correct wall plugs are used for the type of wall that the stud work is being connected to.

Ensure the plug or fuse spur is fully accessible.

9.1 INSTALLATION – EXISTING OPENING IF INSTALLING THE APPLIANCE INTO AN EXISTING CHIMNEY BREAST THE FLUE MUST BE BLOCKED OFF.

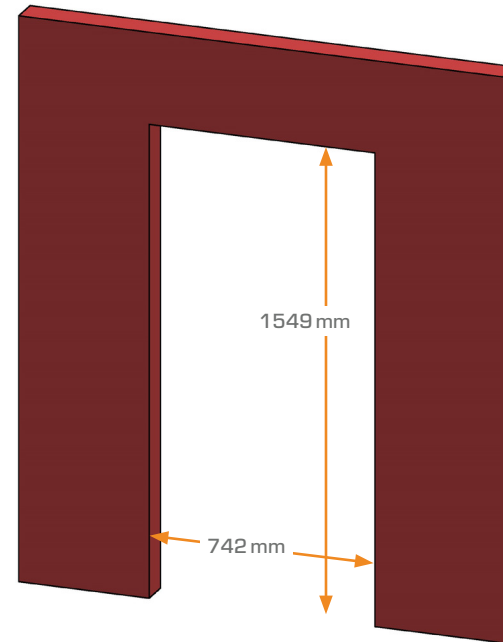

KNIGHTWOOD OPEN DIMENSIONS

HEIGHT	WIDTH	DEPTH
1549 mm	742mm	392 mm minimum

PLEASE NOTE: Before drilling into wall, always check that there are no hidden wires, pipes, etc. Make sure that the screws and wall plugs supplied are suitable for supporting the unit to the surface. Consult a qualified person if you are not sure.

9.1 INSTALLATION – EXISTING OPENING

- 1) Insert the appliance in to place then with a pencil, mark out on the wall the 2x hole positions.
- 2) Remove the appliance from its position. Then with an 8mm drill bit, if using the wall fixing supplied drill 2x holes 50mm deep.
- 3) Insert the wall plugs into the wall. Then plug the appliance into the wall and check the power to the appliance. Refer to sections 11.0 & 12.0, page 16 & 17, on how to sync the remote and operate the appliance.
- 4) Once the power to the appliance has been confirmed, insert the appliance back into the opening, lining the holes in the brackets with the holes in the wall.
- 5) Screw the wall screws through the wall brackets on the appliance and into the wall plugs into the wall and tighten, securing the appliance into place.

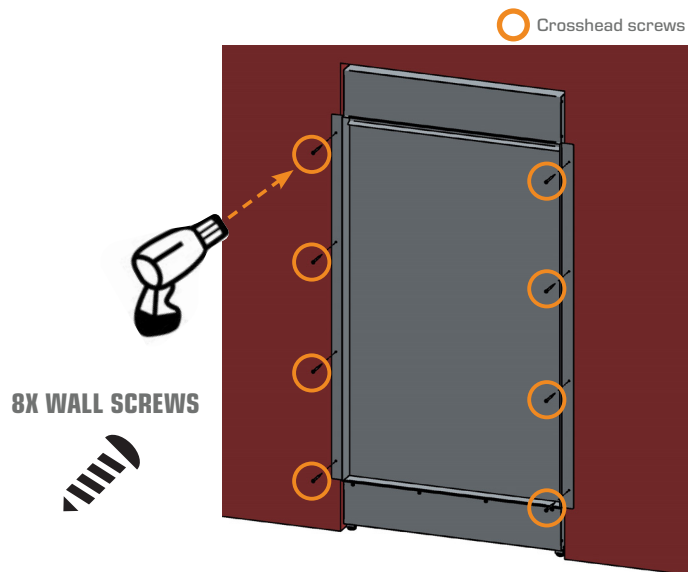

⚠ WARNING

The wall where the appliance is to be installed must be capable of long-term support of the total load of the appliance. Measures should also be taken to ensure sufficient strength to withstand the force of earthquakes, vibration and other external forces. Plasterboard alone is not considered to be a structural material. It is not recommended to rely on plasterboard fixings alone to support the weight of the appliance.

Check regularly for security of wall fixings as appropriate. Also check security of supply cable and connections. If the supply cable becomes damaged, it must be replaced by a service agent or competent person, such as a qualified electrician.

Once the appliance is in the correct position install the plaster board onto the wall. Ensure that the firebox is not drilled into when installing the plaster board. Then refer to section 9.2 on pages 11 & 12 on how to remove the front glass and install the fuel bed layout.

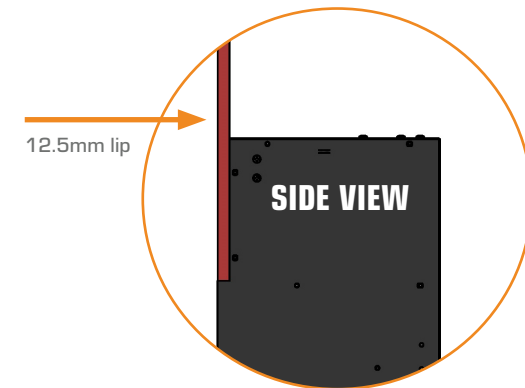

9.2 INSTALLATION – STUD WALL

This appliance should be positioned on a firm level surface and in a clean 'dust free' environment.

Once the frame work has been constructed and secured to the wall and the appliance is in its end position, ensure that there is power to the appliance before any cladding/plasterboard is installed.

For a stud wall installation, create a structure with an opening to the dimensions stated to the right. Ensure the structure is safely secured to the wall using the appropriate fixings. For further information, please see relevant section 9.0 for further information.

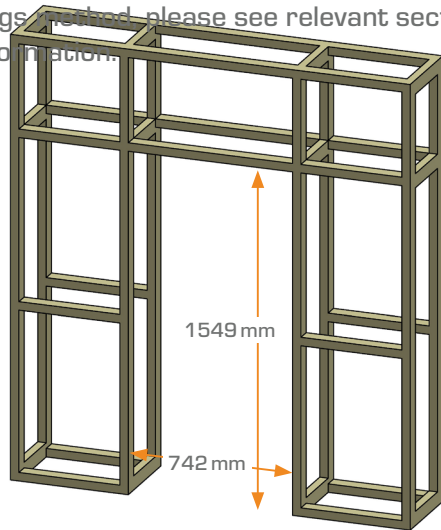

OPEN DIMENSIONS FOR KNIGHTWOOD STUDWALL INSTALLATION

HEIGHT	WIDTH	DEPTH
1549mm	742mm	390mm minimum

- 1) Insert the appliance into the false chimney breast. With a pencil mark through the wall fixing bracket on to the wall/studding where you wish to attached the appliance to the structure.
- 2) Remove the appliance from the position and use an appropriate drill size for the chosen wall fixing.
- 3) Return the appliance to its finished position.
- 4) Screw the wall screws through the wall brackets on the appliance and into the stud work and tighten, securing the appliance into position.
- 5) Once the appliance is in the correct position plug the appliance into the wall and check the power to the appliance. Refer to sections 11.0 & 12.0, page 14 and 16 on how to sync the remote and operate the appliance.

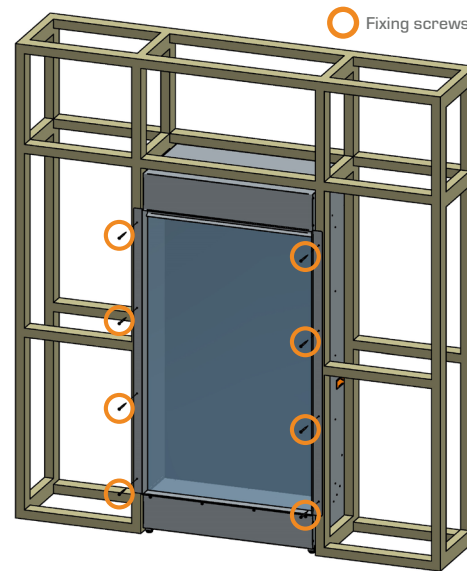

9.2 INSTALLATION – STUD WALL

STUD WALL INSTALLATION CONTINUED

Once the power to the appliance has been confirmed, insert the cladding onto the stud work. Ensure that the firebox is not drilled into when installing the cladding to the structure. Then refer to section 8.1, pages 7 & 8, on how to remove the front glass and install the fuel bed layout.

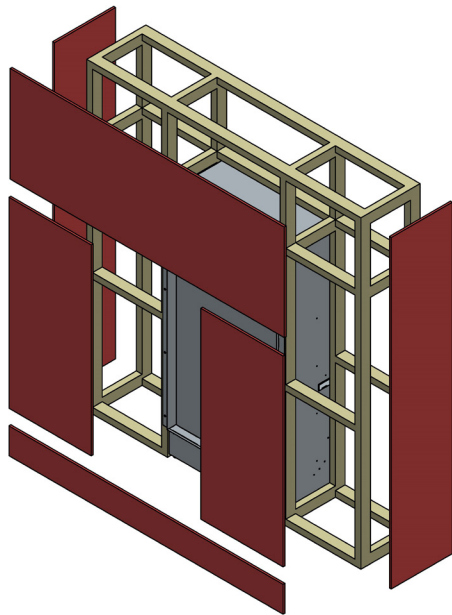

DO NOT DRILL THROUGH HIGHLIGHTED SECTION BELOW

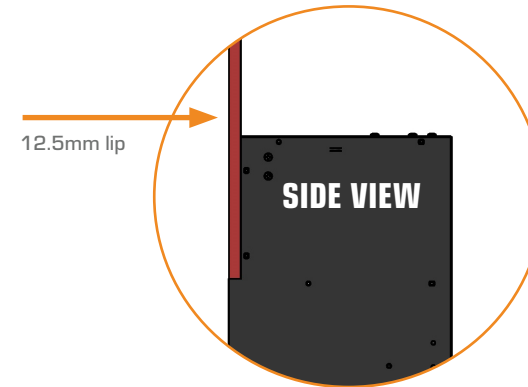
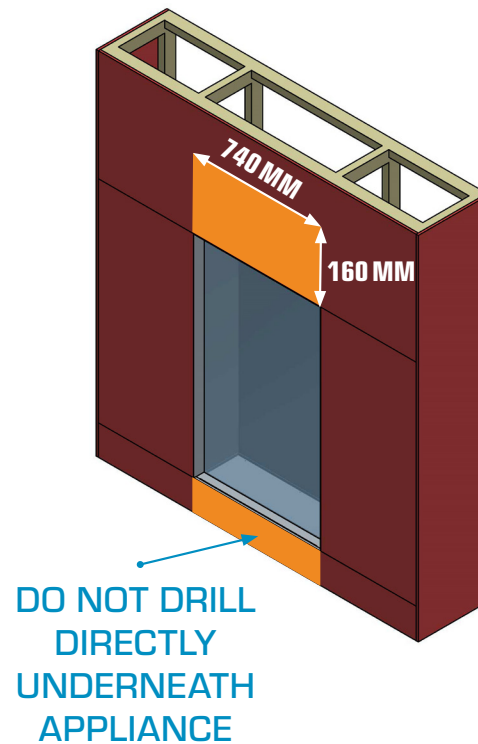

IMPORTANT:

Do not drill through the appliance when installing the cladding into position! The power cable is located at the bottom of the appliance!

10.0 INSTALL THE DELUXE REAL LOGS

WE STRONGLY RECOMMEND PROTECTIVE GLOVES ARE USED WHEN HANDLING THE GLASS

- 1) See section 8.1 on page 10 on how to remove the front glass in order to access the fuel bed then follow the remaining steps here on how to install the Deluxe Real Log fuel bed
- 2) Remove the six (6x) screws that hold the fuel bed into position, then carefully remove the fuel bed tray from the appliance and place safely to one side. A flat head screw driver can carefully be used to lever the fuel bed out if extra help is required.

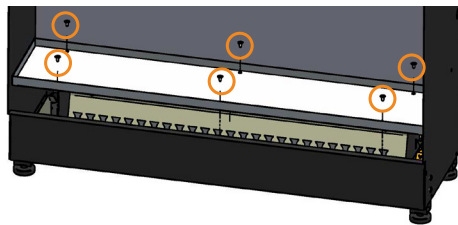

○ Crosshead screws

- 3) Carefully place the deluxe fuel bed tray into position and line the holes in the fuel bed up with the holes in the firebox. Insert the two (2x) 1½ inch wood screws that secure the fuel bed into position.

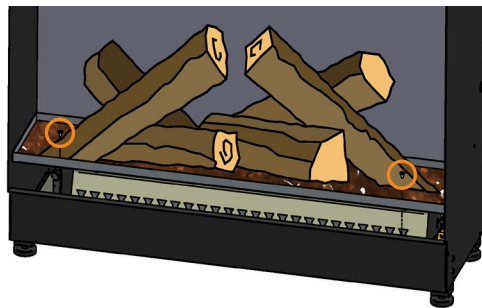

- 4) Using the suction cups, carefully, lift the front glass into the front slot at the bottom of the appliance, then carefully offer the top of the glass back into position.

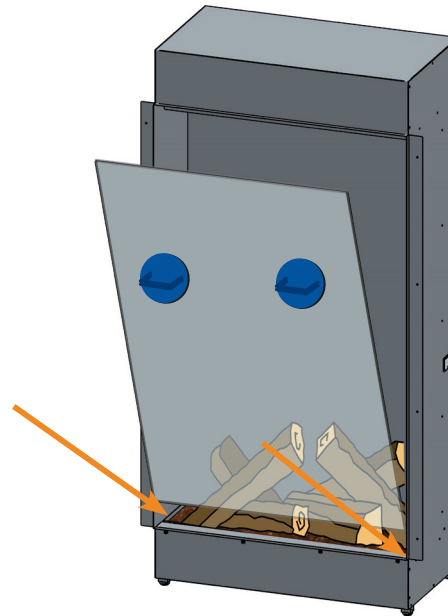

- 5) Use a cross headed screwdriver to screw the (4x) screws through the glass retaining bracket of the appliance, holding the glass in place.

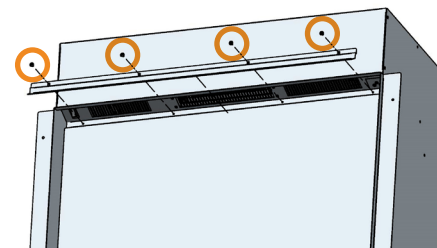

○ Crosshead screws



11.0 PAIRING THE REMOTE CONTROL

The ON/OFF switch is located on the front, top left hand side of the appliance. Press the O/I button once to turn the fire on. The appliance will then automatically after powering on. All other features will need to be activated by the remote after pairing.

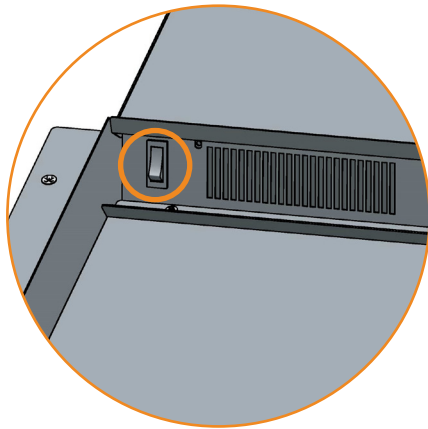

Within 1 minute of turning the power on by the main ON/OFF switch (located on the front, top left hand side of the appliance), press and hold and the 🔥 and 🌡️ buttons on the remote control for 3 seconds, to remotely pair to the appliance, the LCD only displays bL (displayed at the display temperature position) and flashes for 5 seconds, then returns to the current display state. The remote is then paired to the appliance.



12.0 OPERATING THE KNIGHTWOOD



REMOTE CONTROL

The button distribution of the remote controller is as shown right, and the current state information of the electric fireplace, such as the flame effect, fuel bed, setting, temperature and time set, is displayed on the LCD screen on the remote control.

1) STANDBY

Turns the appliance ON/OFF standby, the default settings are: heater set to 27°C, the main flame effect is F1, the Fuel bed is L1 (no temperature display).

2) FLAME CONTROL

Changes the flame effect brightness F1, F2, F3, F4, F1 (cycle adjustment)

3) HEATER

Heater button switches to the temperature adjustment option when the weekly timing function is adjusted. Then use the \oplus and \ominus buttons to select the desired temperature. The temperature cannot be adjusted while the daily timer control is in use. Only the heating function can be switched.

Temperature Setting range:

17°C, 18°C, 19°C, 20°C, 21°C, 22°C, 23°C, 24°C, 25°C, 26°C, 27°C, ON, 17°C [Cycle]

*Press and hold the heater button for three seconds can transfer from °C to °F.

4) FUEL BED

Changes the color of the fuel bed. L1, L2, L3, L4, L1 (cycle adjustment)

5) SLEEP TIMER

Adjusts the timer: 1H, 2H, 3H, 4H, 5H, 6H, 7H, 8H, 9H, OF, 1H (cycle)

6) DOWN LIGHT

Turns the down lighting ON/OFF, (the down light symbol will be lit when it is turned on).

7) TIME AND WEEK SETTINGS

Press to enter the time and week timer settings.

8) LOWER TEMPERATURE 1°C

Press this button to lower the temperature by -1° , incrementally, while heating is on.

9) RAISE TEMPERATURE 1°C

Press this button to raise the temperature by $+1^\circ$, incrementally, while heat is on.

10) DATE SET

To choose from Monday to Sunday or week timer mode option. Option mode:1-2-3-4-5-6-7-A-oF.

12.0 OPERATING THE KNIGHTWOOD

STANDBY BUTTON:

Turns the appliance ON/OFF standby, the default settings are: heater set to 27°C, the main flame effect is F1, the Fuel bed is L1 (no temperature display).

CHANGING FLAME EFFECT:

In the power-on state, press this button, the digital screen displays the flame position and the flame indicator is bright, and the main flame position can be adjusted. The flame brightness settings are: F1, F2, F3, F4, **Set as follows:**

BUTTON	DISPLAY	FLAME EFFECT
1st Press	F1	Full
2nd Press	F2	Medium
3rd Press	F3	Low
4th Press	F4	Cycle through settings

HEATING OPERATIONS:

1) Press the heater button to turn the heating function on and off and adjust the temperature setting. Heater is divided into temperature settings: 17°C, 18°C, 19°C, 20°C, 21°C, 22°C, 23°C, 24°C, 25°C, 26°C, 27°C, ON, 17°C (Cycle)

2) Press and hold the heater button for 3 seconds to convert the temperature unit from °C to °F. The temperature display window will flash. After the temperature is set, the display unit will flash 5 times, then automatically save the settings and exit the setting state. After the display unit is turned on, if there is no operation within 10 seconds, the setting status is also exited.

3) Fan delay function: After the appliance is turned off, the fan will continue running for 15 seconds then stop.

Open Window Detection function: When the appliance is heating and the ambient temperature suddenly drops $\geq 5^{\circ}\text{C}$ within 10 minutes, and the environment cannot be warmed up within 30 minutes the appliance will automatically display "OP". The heating function will then be automatically turned off, and when the "OP" is displayed, it can be turned off and then restarted by turning off and on the appliance to clear the fault code.

4) This appliance has a non-self-resetting overheat protection device (thermal cut-out) which will activate if the air inlets or outlets are obstructed. For safety reasons the fire will NOT switch on again automatically, the following procedure must be carried out before the fire can be operated.

NOTE: The flame-effect will remain operational if the cut-out is activated, only the fan heater is prevented from working.

Switch OFF the appliance at the wall socket or outlet. Leave the fire OFF for a period of no less than 10 minutes, ensuring all obstructions are removed. Switch the appliance ON at the wall. Ensure the appliance is turned ON at the control switches. If the fire fails to operate correctly, repeat the above procedure.

Refer to section 13.0, page 20 for more information about the Safety Cut-Out System.

FUEL BED COLOR OPTIONS: 

Once powered, press the “Fuel Bed” button and the LCD screen on the remote will display the fuel bed icon. Now, the fuel bed color can be adjusted. The different settings are: L1, L2, L3, L4; Fuel bed light. **Set as follows:**

BUTTON	DISPLAY	FLAME EFFECT
1st Press	L1	Orange
2nd Press	L2	Blue
3rd Press	L3	Orange + Blue
4th Press	L4	Cycle through settings

SETTING SLEEP TIMER: 

In the timed display, press the “Sleep Timer” button to adjust the time, plus one hour for each press. (You can’t enter the weekly timing selection, you can only set the current automatic shutdown time. This function is available when the weekly timing function is turned on. Will not operate). Timing range: 1H, 2H, 3H, 4H, 5H, 6H, 7H, 8H, 9H, 0F, 1H (cycle adjustment).





Control Down Lighting: 

Turns the down lighting lights on and off.

Setting Clock and Timer: 

Use the date button to choose from Monday to Sunday or week timer mode option. Option mode: 1-2-3-4-5-6-7-A-oF.

CLOCK SETTING:



- 1)** At standby state (after the unit is plugged in and before pressing “main power”), press and hold the Setting button on the remote for 3 seconds, the digital display will then flash “00:00”.
- 2)** Press  on the remote control to set the hour, press the remote control  to set the minutes.
- 3)** Press “Setting” to enter the setting of the week timer. Press  to select Sunday to Saturday, The date symbol will light up after the day is selected. When finished, press the  button to exit setting.

NOTE:







The current clock must be set after the initial power-on or power-off, otherwise the clock will remain “00:00” status and you won’t be able to set the week timer function.

12.0 OPERATING THE KNIGHTWOOD



HEAT SETTINGS:



Use the remote control's Heater button  to select the temperature. The system default parameters are: 27°C. Press  &  buttons to select the temperature when the heating is turned on. Temperature range: 16°-27°C; ON; 16°C; (Cycle).

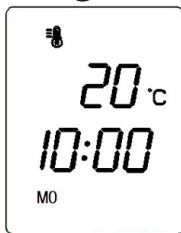

Timing switch ON/OFF preset:

1) While in the standby state, press the sleep timer  button on the remote for three seconds to pre set timing switch on/off the week timer. Enter mode 1, while the display is "1 ON", the clock will be "01:00", press  to set hour, press  to set minute, press  to set the week, every press on the  will show SU, MO, TU, WE, TH, FR, SA and flash in turn, you can use the  key to select or de-select the desired date. The ▲ indicates all of the selected days. Press the "Heater"  button to enter the temperature



setting, then press the  &  button to set temperature.

2) Press "Setting"  again to set the timer switch off, the display is 1 OFF, the clock is displayed as "02:00", press  to set hour, press  to set minute, the date of the timer off is the same as the timer on, you can't change this manually. After





setting, press  to enter the setting of mode 2, which operates the same as mode 1. You can set mode 1 to mode 7 with the above method. Press  or  on the remote for 3 seconds to save setting and exit week timer setting.

3) After the preset timing ON/OFF switch, you can use the clock/timer  button to select the desired timing mode 1 - 2 - 3 - 4 - 5 - 6 - 7 - auto option, after the option shows five seconds without any operation, it will



save the selected option and enter the current setting of the option, the timer logo of the display lightens and will automatically run the preset switch setting program. You can individually select each setting of modes 1-7 for automatic ON/OFF switching, or you can preset the desired settings, and then select "auto mode" for multiple preset series executions.

4) If you want to set the ON/OFF switch and temperature setting for different periods of the week, then set the switching time and temperature of each day from Sunday to Monday in mode 1-7. After setting, use the "auto mode" to run timing switch and then the system will run the week timer of 1-7 modes. You can also set 1-7 modes within 1 day, use the "auto mode" to run timing switch ON/OFF within one day. Be aware that when you use "auto mode", you need to make sure the settings of times does not overlap each other, otherwise the timer will not operate.

5) After entering the week timer setting, press the  button for 3 seconds to exit the week timer mode, then the timer symbol will be extinguished. You can check the 1-7 timer settings by pressing the "Setting"  button. For example: press  to display (1 ON "01:00" temperature 27°C), press  again to display (1 OFF "02:00" temperature 27°C). Press the "Setting" button again to display (2 On "03:00" temperature 26°C) then press the Setting button to display (2 OFF "13:00" temperature 27°C). The wireless remote control and the appliance must be kept within 4 meters to prevent the remote control and the appliance from failing due to the distance exceeding the effective remote control range when working at the weekly timing. After the weekly time is turned on, the remote controller automatically controls the appliance at the set appointment time.

13.0 SAFETY CUT-OUT SYSTEM

This appliance has a non-self-resetting overheat protection device (thermal cut-out) which will activate if the air inlets or outlets are obstructed. For safety reasons the fire will NOT switch on again automatically.

The following procedure must be carried out before the fire can be operated again:

- 1) Switch OFF the appliance at the wall socket or outlet. Leave the fire OFF for a period of no less than 10 minutes, ensuring all obstructions are removed.
- 2) Switch the appliance to ON at the wall.
- 3) Ensure the appliance is turned ON at the ON/OFF switches.

NOTE: During the cut-out test the fire will automatically display '88'.

If the fire fails to operate correctly, repeat steps one and two. If an attempt to switch on the appliance is made before the safety cut-out has reset, the appliance may cut-out for a further period of time.

If the sequence has been followed correctly and the appliance still fails to function, check the fuse in the wall outlet. If this is not the cause, call an electrician or maintenance engineer.

NOTE: The flame-effect will remain operational if the cut-out is activated and only the fan heater is prevented from working.

14.0 CLEANING AND MAINTENANCE

CLEANING:

For general cleaning use a soft clean duster – never use harsh abrasive or cleaners. The glass panels should be cleaned carefully with a soft cloth. Remove the front facing glass pane in order to clean the inside of the pane. Please refer to section 8.1 to do this.

Except for periodic cleaning of dust, there are no specific requirements for care, other than regular cleaning of the general appliance. A wipe with a dry cloth is normally sufficient. DO NOT use abrasive cleaners as they can damage the finish. Make sure the heater outlet and inlet grille (located on the top, front, centre of the appliance) is kept clear of dust, pet hair and other airborne household matter. These should be vacuum cleaned periodically using a brush attachment. The LED light strips are designed and tested to last 20,000 hours.

HANDSET BATTERY REPLACEMENT

Battery Requirements:
Two (2x) AAA 1.5V

- 1) Remove the battery cover and the used batteries from the back of the remote control.
- 2) Insert the two replacement batteries the correct way into the battery holder – making sure the batteries are firmly seated.
- 3) Then insert the battery cover back into position.
- 4) You will then need to pair the remote to the appliance. Please refer to section 11.0 Pairing The Remote Control.

If in doubt consult a qualified electrician. Refer to Section 3.0 Appliance Data for fuse specification. Excluding fuses, use only genuine manufacturers spare parts available from your supplier.

CAUTION:

Always disconnect the appliance from the mains supply outlet socket before undertaking any cleaning or maintenance!

15.0 TROUBLESHOOTING GUIDE

MY KNIGHTWOOD LED ELECTRIC FIRE...	REMEDY
is not switching on	Ensure mains switch is on. Replace the fuse in the plug.
is not emitting any heat	The fire is fitted with an energy saving thermostat. If the temperature in the room is higher than the temperature selected on the fire, then the thermostat will stop the heater from turning on. For example, if the room temperature is 22°C or above and the fires heater is set at 22°C, then the heater will not be required until the room temperature drops below 22°C. If this is the case select a higher temperature setting than the room's temperature and the heater will begin to operate. The safety cut-out may have been operated. Switch the appliance off, leave for 10 minutes then switch back on.
shuts off after a period of time	<p>Check that the temperature is not set onto the lower settings. If the room is warm enough the thermostat will stop the fire switching the heat on.</p> <p>Check that the air inlet/outlet is blocked off.</p> <p>Check that the window detection sensor has not activated.</p>
Display panel shows	<p>88 There is a fault with the heater. Check that the temperature is not set onto the lower settings. If the room is warm enough the thermostat will stop the fire switching the heat on. Check that the air vent are not blocked off.</p> <p>EE There is an electrical fault. A service engineer will need to check the thermostat for any loose connections.</p> <p>OP The open Window Detection function is in operation, this operates when the appliance is heating and the ambient temperature suddenly drops $\geq 5^{\circ}\text{C}$ within 10 minutes, and the environment cannot be warmed up within 30 minutes, resulting in the appliance automatically displaying "OP." The heating function will then be automatically turned off, and when the "OP" is displayed, it can be turned off and then restarted by turning off and on the appliance to clear the fault code.</p>

16.0 SERVICING

There are no internal user serviceable parts.

As the colours of the wires in the mains lead of this appliance may not correspond with the colour markings identifying the terminals in your plug, proceed as follows.

The blue wire must be connected to the terminal marked with an N or coloured black. The brown wire must be connected to the terminal marked with an A or coloured red. The green/yellow wire must be connected to the earth terminal which is marked with an E or with the earth symbol.

IMPORTANT: The wires in the mains lead are coloured in accordance with the following code:

Blue/Black	Neutral
Brown/Red	Active
Green/Yellow	Earth

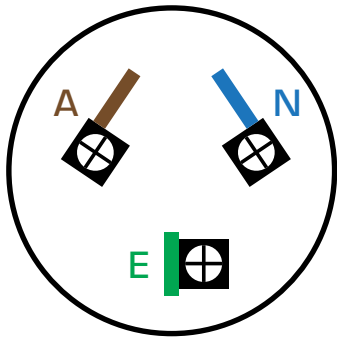

WARNING:

Never connect live or neutral wires to the earth terminal of the plug.

NOTE:

If a moulded plug is fitted and has to be removed take great care in disposing of the plug and severed cable, it must be destroyed to prevent engaging into a socket. Refer to Section 3.0, Appliance Data for fuse specification. Excluding fuses, use only genuine manufacturers spare parts available from your supplier.

17.0 SPARE PARTS

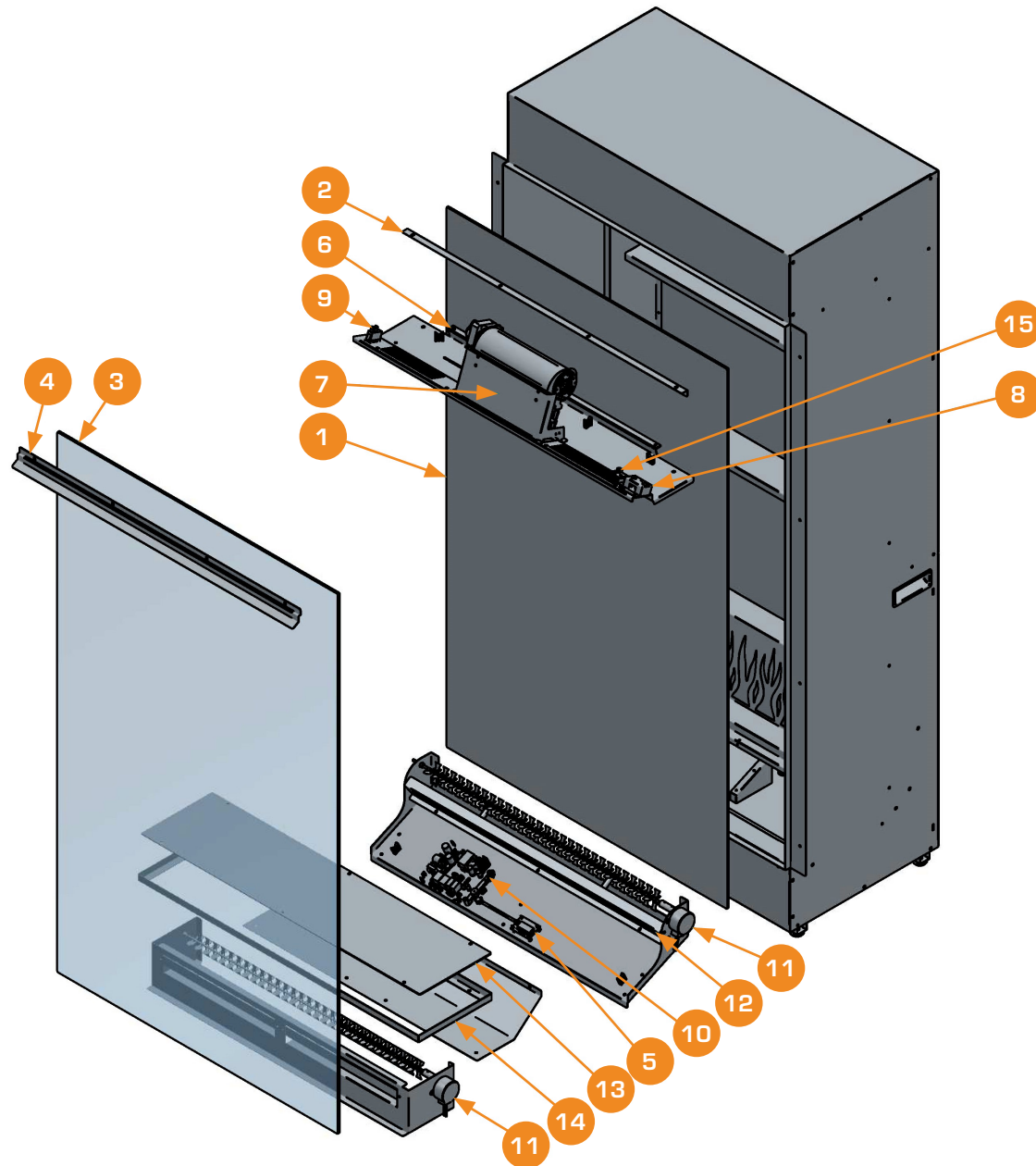

Knightwood LED Electric Fire Spares

- 1 - F960338 Rear Glass Panel
- 2 - F960340 Rear Glass Retaining Bracket
- 3 - F960307 Front Glass Panel
- 4 - F960264 Front Glass Retaining Bracket
- 5 - F960273 Remote Receiver
- 6 - F960265 Downlighting Led Light Strip
- 7 - F960342 Heater & Fan Assy
- 8 - F960343 Cavity Box (Optional Extra)
- 9 - F960275 Feedback Display Panel
- 10 - F960271 Isolator Switch
- 11 - F960341 Fixing Kit Including Brackets & Screws
- 12 - F960267 PCB
- 13 - F960269 Rotisserie Motor
- 14 - F960266 Flame Effect LED Strip
- 15 - F960334 Frosted Fuelbed
- 16 - F960333 Fuelbed Tray
- 17 - F960274 NTC Thermostat
- 18 - F960268 Remote Handset

18.0 KNIGHTWOOD DIMENSIONS

A	802.0 mm
B	1525.0 mm
C	1159.0 mm
D	717.0 mm
E	151.0 mm
F	174.0 mm
G	392.5 mm
H	725.0 mm
I	380.0 mm

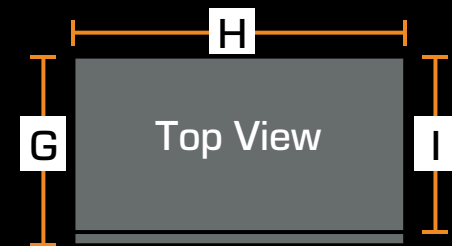
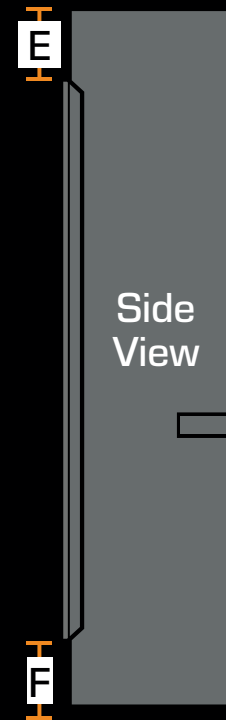
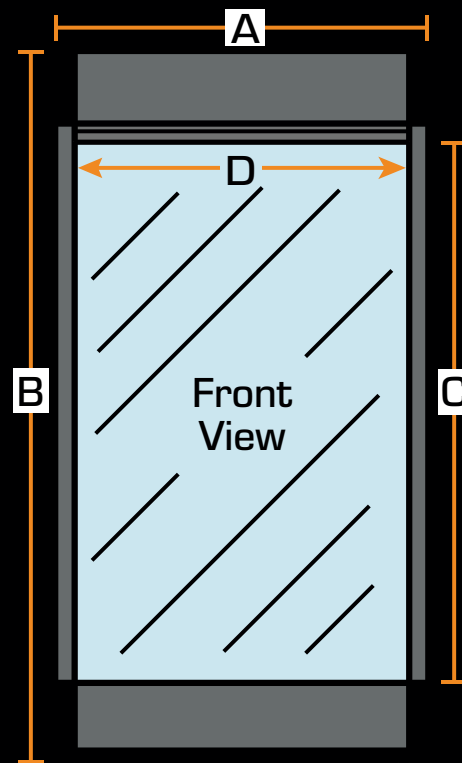

19.0 GUARANTEE, TERMS & CONDITIONS

Automatic 3-year Guarantee

At British Fires we pride ourselves on quality and performance, so much so that each of our appliances is eligible for a three-year guarantee when purchased from an authorised dealer. Full warranty terms and conditions are available to view at www.britishfires.com.au.

Terms & Conditions

All appliances must be installed in a correctly ventilated space in accordance with the manufacturer's installation instructions and the rules in force. All of our fires carry SAA approval. June 2023 British Fires Ltd.

- 1) For any claim to be made within three years from date of purchase you will be required to provide and supply your original proof of purchase.
- 2) All appliances must have been installed and operated in accordance with the manufacturer's instructions.
- 3) Purchase(s) must be made through an authorised stockist/retailer.

Please note all consumable items such as any ceramics including; coals, pebbles, logs, bark, crystals, rear panels are not covered by the 3-year guarantee.

During the guarantee period any appliance or component which is proved to be faulty or defective in manufacture, will be repaired or replaced free of material and labour charges, providing that we have authorised or carried out the repair or replacement. We will not accept or reimburse the costs of any third-party who undertakes any work carried on the appliance or fits parts, unless we have approved such work in advance of it being carried out. The guarantee period will not be extended even if we repair or replace any appliance or part.

Making a claim:

If you wish to make a claim under our guarantee and all the terms and conditions for your appliance have been met then your initial contact must be made to the dealer/company from where you purchased the appliance. The relevant dealer will carry out initial troubleshooting and determine a reasonable course of action.

If you have any queries concerning the appliance, please send us an email.

Email: sales@britishfires.com.au

Phone: 1800 271 040



Waste electrical appliances should not be disposed of with household waste. Please recycle where facilities exist. Check with your local authority or retailer for recycling advice. As our policy is one of continuous improvement and development, we therefore, hope that you will understand we must retain the right to amend details and/or specifications without prior notice.



This product complies with conformity requirements of the applicable European Regulations or Directives.



Certificate No. SAA-230369-EA



Model covered by these instructions:
Knightwood LED Electric Fire (EF40-65A)

This appliance is only suitable for well insulated spaces or occasional use. Please note: Except where otherwise stated, all rights, including copyright in the text, images and layout of this booklet is owned by British Fires. You are not permitted to copy or adapt any of the content without the prior written permission of British Fires.
© 2024 British Fires

All instructions must be handed to the user for safekeeping.
Revision A – 05/24

British Fires Ltd

Distributed in Australia by:

Dragon Wholesaling Pty Ltd
PO Box 8051 Baulkham Hills BC.
NSW 1755

T: 1800 271 040

W: britishfires.com.au

E: sales@britishfires.com.au